

# YA/YH Series

Arctek proudly presents to you a brand-new product with up-to-date strength and quality. The arctek YA/YH series is designed and manufactured to the latest and toughest industrial standard, ANSI A156.2 (2011) Series 4000 Grade 1. In this recent change, a major upgrade was made in the endurance requirement, increasing from 800,000 to 1,000,000 cycles. The YA/YH series not only passes but exceeds the new requirement.

Our product satisfies a wide range of commercial applications with its function, lever and latch options. Ideal for business owners, builders, real estate agencies and more, YA/YH locks provide quality yet cost-effective Grade 1 security.

The YA/YH Series is easy to install and maintain, and perfect for settings requiring reliability and performance. Our patent-pending door thickness adjustment design (pull-and-click) makes installation quick and easy even for amateur installers.

Quality yet cost-effective, the YA/YH Series overachieves the toughest standard without any compromise on a user-friendly and convenient design.



YA / YH  
Series



## Pull-and-Click Door Thickness Adjustment

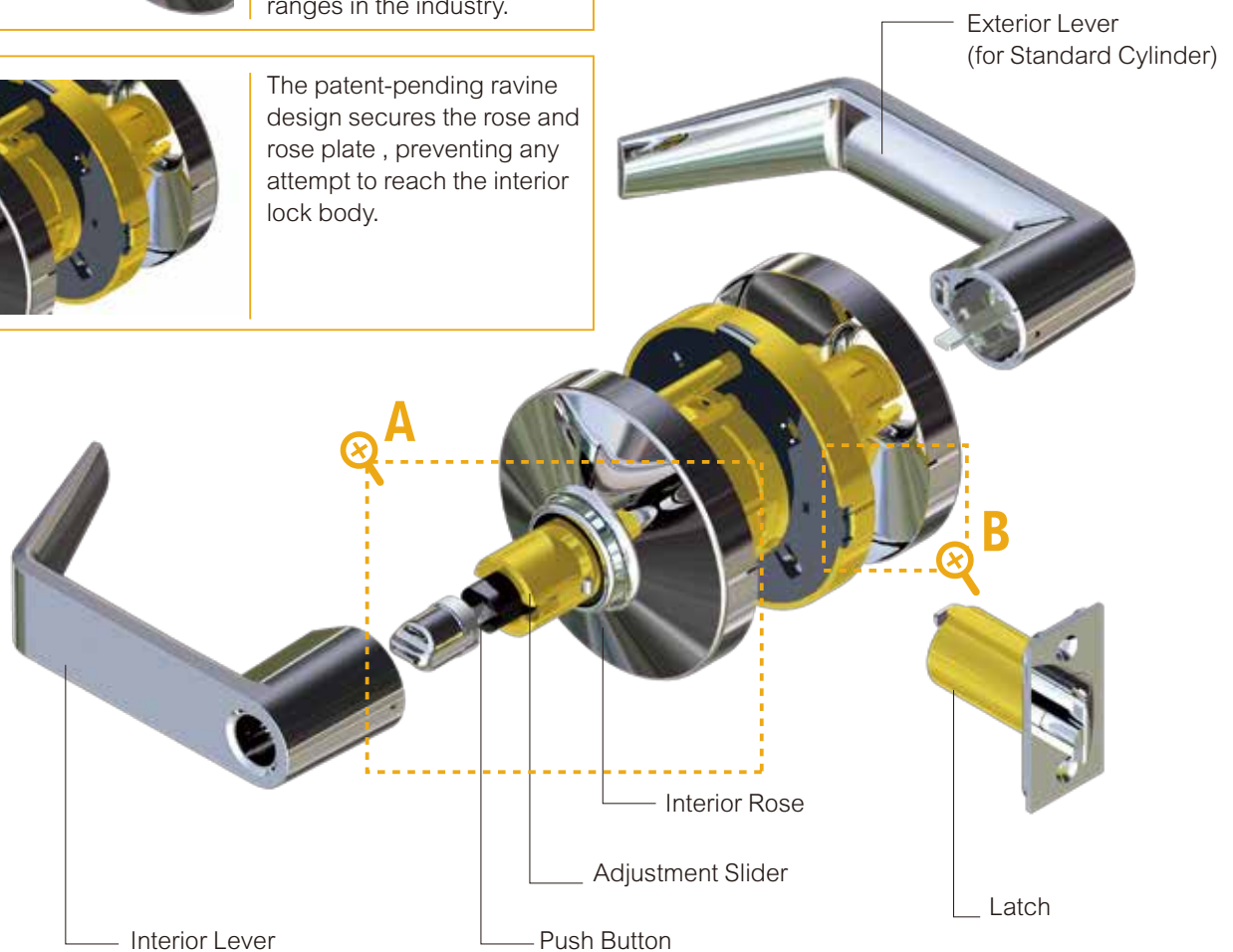
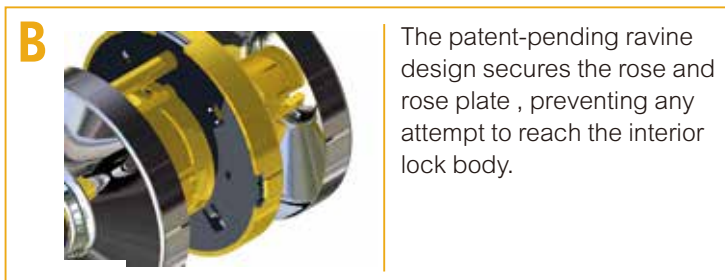
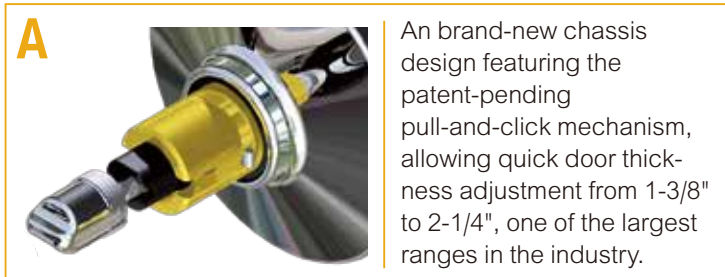

## YA / YH Series with Lock-and-Roll Protection

Lock-and-Roll Protection allows the exterior lever to freely rotate while remaining securely locked. This minimizes damage to internal lock mechanisms when excessive forces are applied during an attempted break-in. This feature will be especially beneficial in areas where vandalism is likely to be present such as dormitories, campuses, and public or commercial facilities.

All our levers come pre-equipped with this function to enhance your customer's security.

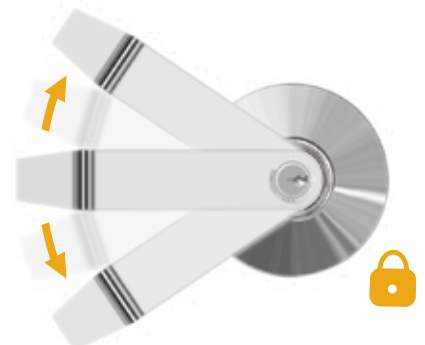

YA / YH  
Series



## Lever Options

▪ YA / YB : Standard Cylinder    ▪ YG / YH : Interchangeable Core

Hanover  
YA01 / YH01  
YB01 / YG01

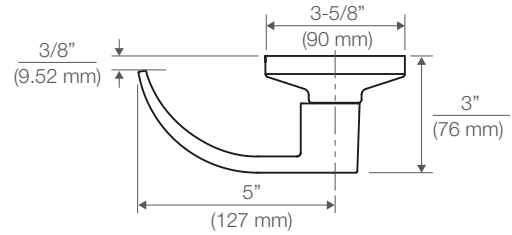

Calypso  
YA03 / YH03  
YB03 / YG03

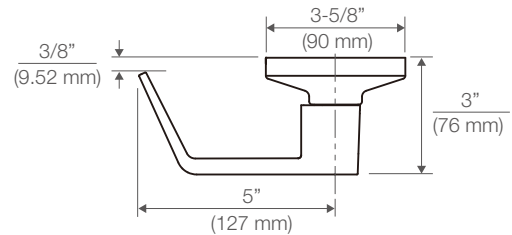

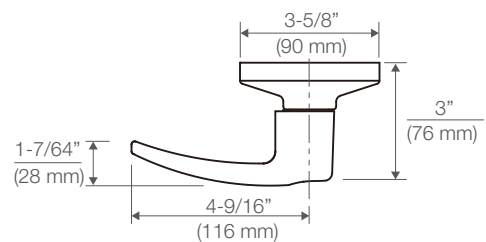

Fairford  
YA0F / YH0F  
YB0F / YG0F



 = Standard cylinder.

 = Complies with ADA Accessibility Guidelines.

 = SFIC (Standard Format Interchangeable Core, optional).

 = Meets California Code requirements for sub-1/2\" data-bbox="489 850 928 875"/>

 = Available with anti-microbial finish.



YA / YH  
Series



# Functions

▪ YA / YB : Standard Cylinder    ▪ YG / YH : Interchangeable Core

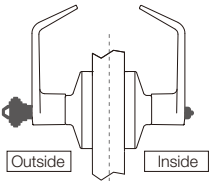
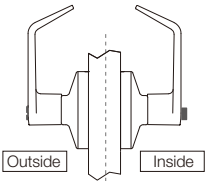
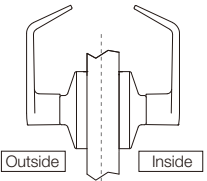
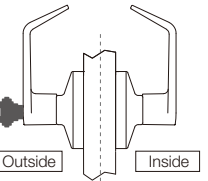
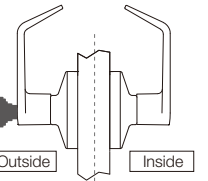
ANSI A156.2 (2011) Series 4000 Grade 1

	<b>Product</b> YA / YH (D0) <b>ANSI</b> F109		<b>Product</b> YA (T0) <b>ANSI</b> F76A		<b>Product</b> YA (30) <b>ANSI</b> F75		<b>Product</b> YA / YH (S0) <b>ANSI</b> F86		<b>Product</b> YA / YH (R0) <b>ANSI</b> F84	
	<b>Entry Lock</b>		<b>Privacy, Bedroom or Bath Lock</b>		<b>Passage or Closet Latch</b>		<b>Storeroom or Closet Lock</b>		<b>Classroom Lock</b>	
	<ul style="list-style-type: none"> <li>▪ Ideal for entrance or office doors.</li> <li>▪ Dead locking latch bolt operated by lever from either side except when outside lever is locked by the push or turn button on inside.</li> <li>▪ Key outside or operating inside lever releases push or turn button unlocking outside lever except when push or turn button has been rotated to keep outside lever locked.</li> <li>▪ Inside lever always operates latch bolt.</li> </ul>		<ul style="list-style-type: none"> <li>▪ Ideal for lavatory or other privacy doors.</li> <li>▪ Latch bolt operated by lever from either side.</li> <li>▪ Outside lever is locked by push button inside and unlocked by emergency release outside, operating inside lever or closing door.</li> </ul>		<ul style="list-style-type: none"> <li>▪ Ideal for doors that do not require locking.</li> <li>▪ Latch bolt operated by lever, from either side at all times.</li> </ul>		<ul style="list-style-type: none"> <li>▪ Ideal for storeroom, utility, or exit doors.</li> <li>▪ Dead locking latch bolt operated by key in outside lever, or by operating inside lever.</li> <li>▪ Outside lever is always inoperable.</li> <li>▪ Operating the key in outside lever shall permit the latch bolt to be retracted by operating the outside lever, providing the key cannot be removed in the unlocked position.</li> </ul>		<ul style="list-style-type: none"> <li>▪ Ideal for classroom or utility room doors.</li> <li>▪ Dead locking latch bolt operated by lever from either side except when outside lever is locked from outside by key.</li> <li>▪ Operating the key in the lever shall permit the latch bolt to be retracted.</li> <li>▪ When outside lever is locked, latch bolt is operated by inside lever.</li> </ul>	
										
	N/A	Interior Push Button	N/A	Interior Push Button	N/A	N/A	Auto-lock	Auto-lock	Key	N/A
	Key	Interior Lever (Emergency Egress)	Trench (coin)	Interior Lever (Emergency Egress)	Exterior Lever	Interior Lever	Key	Interior Lever (Auto-lock)	Key	Interior Lever



YA / YH  
Series



# Functions

▪ YA / YB : Standard Cylinder    ▪ YG / YH : Interchangeable Core

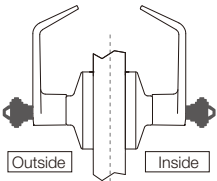
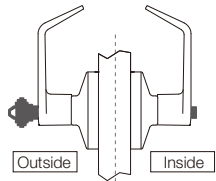
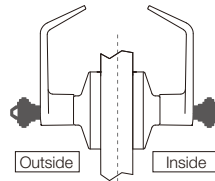
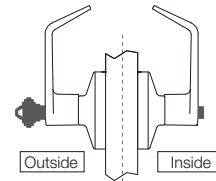
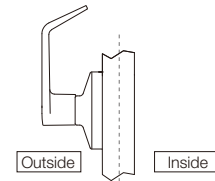
ANSI A156.2 (2011) Series 4000 Grade 1

	<b>Product</b> YA / YH (K0) <b>ANSI</b> F80		<b>Product</b> YB / YG (D0) <b>ANSI</b> F82A		<b>Product</b> YA / YH (P0) <b>ANSI</b> F87		<b>Product</b> YA / YH (Q0) <b>ANSI</b> F90		<b>Product</b> YA (40)	
	<b>Communicating Lock</b>		<b>Entry Lock</b>		<b>Utility, Asylum or Institutional Lock</b>		<b>Corridor Lock</b>		<b>Inactive Lever</b>	
	<ul style="list-style-type: none"> <li>▪ Ideal for communicating or store entrance doors.</li> <li>▪ Dead locking latch bolt operated by lever from either side.</li> <li>▪ Turning key in either lever locks or unlocks its own lever independently.</li> <li>▪ Do not use on doors in rooms that have no other entrance.</li> </ul>		<ul style="list-style-type: none"> <li>▪ Ideal for entrance or office doors.</li> <li>▪ Dead locking latch bolt operated by lever from either side except when outside lever is locked by push button or other locking device on inside.</li> <li>▪ When outside lever is locked, operating in outside lever or operating inside lever unlocks push button or other locking device and retracts latch bolt</li> <li>▪ Closing door does not release push button or other locking device.</li> </ul>		<ul style="list-style-type: none"> <li>▪ Ideal for utility room or institution doors.</li> <li>▪ Dead locking latch bolt operated by key in lever, from either side.</li> <li>▪ Both levers always inoperable.</li> <li>▪ At the option of individual manufacturer, operating the key in the outside lever shall permit the latch bolt to be retracted by operating either the inside or outside lever, providing the key cannot be removed in the unlocked position.</li> </ul>		<ul style="list-style-type: none"> <li>▪ Ideal for corridor or connecting doors.</li> <li>▪ Dead locking latch bolt operated by lever from either side except when outside lever is locked by key in outside lever or by push button or other locking device on inside.</li> <li>▪ Key in outside lever locks or unlocks the outside lever.</li> <li>▪ Operating inside lever releases push button or other locking device placed in locking position.</li> <li>▪ Closing door releases push button or other inside locking device.</li> <li>▪ Inside lever always operates latch bolt.</li> </ul>			
										
	Key	Same as exterior	N/A	Interior Push Button	Auto-lock	Same as exterior	Key	Interior Push Button	N/A	N/A
	Key	Same as exterior	Key	Interior Lever (Emergency Egress)	Key	Same as exterior	Key	Interior Lever Key/Kick-off	N/A	N/A

**Remark:**

1. Emergency Egress: Door is unlocked automatically when the lever is turned. Door must be manually re-locked.
2. Auto-lock: Door re-locks itself as soon as it is closed.

YA / YH  
Series



## Latch Options

1/2" Latch Throw  
Standard

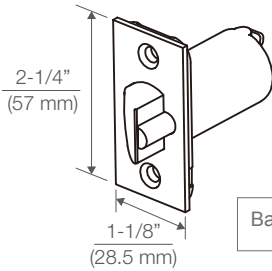

Backset:  $\frac{2-3}{4}$ "  
(70 mm)

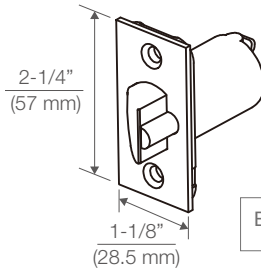

Backset:  $\frac{2-3}{8}$ "  
(60 mm)

3/4" Latch Throw  
Optional

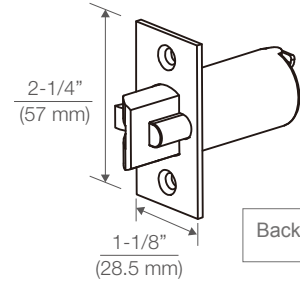

Backset:  $\frac{2-3}{4}$ "  
(70 mm)

## Cylinder

▪ YA / YB : Standard Cylinder    ▪ YG / YH : Interchangeable Core

	Fixed Core (YA / YB) Schlage keyway	Interchangeable Core (YG / YH) Compatible with Best A2 SFIC
Conventional 6-pin	 ※ Standard	 ※ Not included
Conventional 7-pin	N/A	 ※ Not included

## Strike

ANSI Strike  
Standard

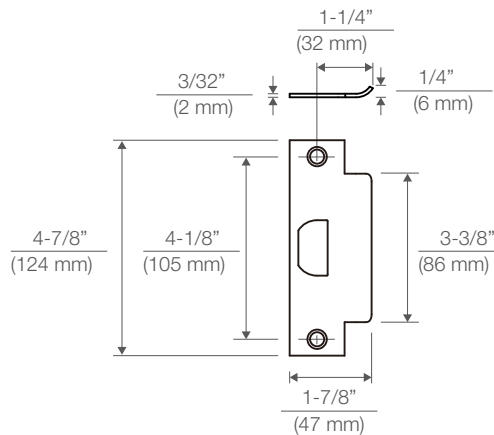
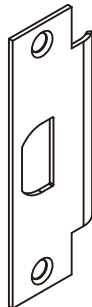

YA / YH  
Series



## Finish Options



## Door Handing

All YA Series levers are field-reversible. Refer to the diagram to determine the correct door handing and ensure proper cylinder orientation in keyed functions.

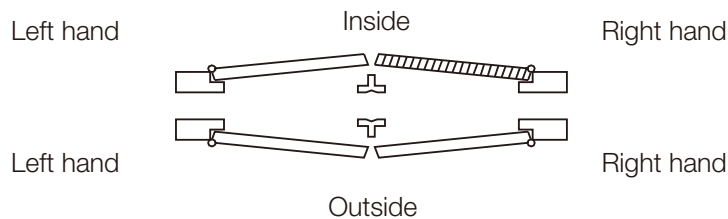

## ADA-Compliant Products



The Americans with Disabilities Act (ADA) is one of America's most comprehensive pieces of civil rights legislation, prohibiting discrimination and guarantees those with disabilities the right to participate in mainstream American life.

Arctek's YA/YH Series fully supports this vision; we vow to help building owners remove barriers and create an easy-access environment for everyone.

**Note:**

Product information in this catalog, including graphics, wordings, and specifications, are subject to change without notice. Please consult the factory or local service provider prior to purchase.



**TAIWAN FU HSING INDUSTRIAL CO.,LTD.**

NO.88, YUCAI RD., GANGSHAN DIST., KAOHSIUNG CITY 820, TAIWAN (R.O.C)

Tel: 886-7-6225151

Fax: 886-7-6225403

Website: <http://www.fuhsing.com.tw>

E-mail: [service@fuhsing.com.tw](mailto:service@fuhsing.com.tw)

**SHANGHAI ARCTEK**

Royal Wealth Center 105

No.7 lane 98 Dan ba Road Business Circle Gubei

Tel: +86(0)21-6070 9191

Fax: +86(0)21-6070 9797

Website: <http://www.arctek.com.cn/en/>

**FU HSING AMERICAS, INC.**

1000 Satellite Boulevard

Suite#101 Suwanee, GA 30024 U.S.A.

Tel:1-770-441-2830

Fax:1-770-441-1587

Customer Service Toll-free No

1-877-ONE-LOCK

